

# Memorandum



DATE: October 21, 2011

TO: Members of the Public Safety Committee

SUBJECT: **Dallas Police Department Fusion Center Update**

Attached is briefing material on the "Dallas Police Department Fusion Center Update" to be presented to the Members of the Public Safety Committee on Monday, October 24, 2011.

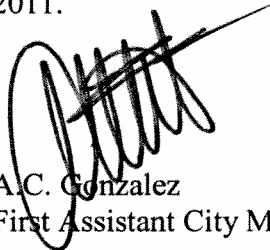

A.C. Gonzalez  
First Assistant City Manager

Attachment

CC: Honorable Mayor and Members of the Dallas City Council  
Mary K. Suhm, City Manager  
Rosa Rios, Acting City Secretary  
Thomas P. Perkins, Jr., City Attorney  
Craig D. Kinton, City Auditor  
C. Victor Lander, Administrative Municipal Judge  
Ryan S. Evans, Assistant City Manager  
Jill A. Jordan, P.E., Assistant City Manager  
Forest E. Turner, Assistant City Manager  
Joey Zapata, Interim Assistant City Manager  
Jeanne Chipperfield, Chief Financial Officer  
Frank Libro, Public Information Office  
Helena Stevens-Thompson, Assistant to the City Manager Mayor/City Council



Dallas Police Department  
Fusion Center Update  
Public Safety Committee  
October 24, 2011



[www.dallaspolice.net](http://www.dallaspolice.net)

David O. Brown  
Chief Of Police



# Purpose

- Provide historical background
- Provide an overview of current capabilities
- Provide an overview of the support role for operational units in the Dallas Police Department and neighboring communities

# Goals

- The DPD Fusion Center provides:
  - Real-time monitoring of calls and field support.
  - Timely tactical intelligence
  - Increased community awareness through relationships and outreach to private sector partners.



# Prior to Fusion

- Collection of information was done by individual units and documented on paper bulletins
- Communication between units was minimal
- Linking between criminal activity was shown on poster boards using pins and string
- Gathering and distribution of information was not done in a timely manner



# Background

- The 9/11 Commission Report – 2004
  - Called for Unity of effort in:
    - Strategic Planning and Intelligence across the Foreign-Domestic Divide
    - Intelligence Community
    - Sharing Information

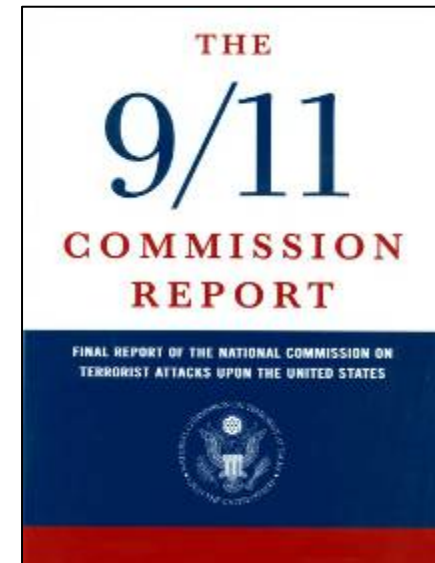

# Background

- 2007 National Strategy for Information Sharing Report recommended:
  - Strong partnerships among Federal, State, local, tribal authorities and private sector
  - State and major urban area fusion centers should be incorporated into the national information sharing framework

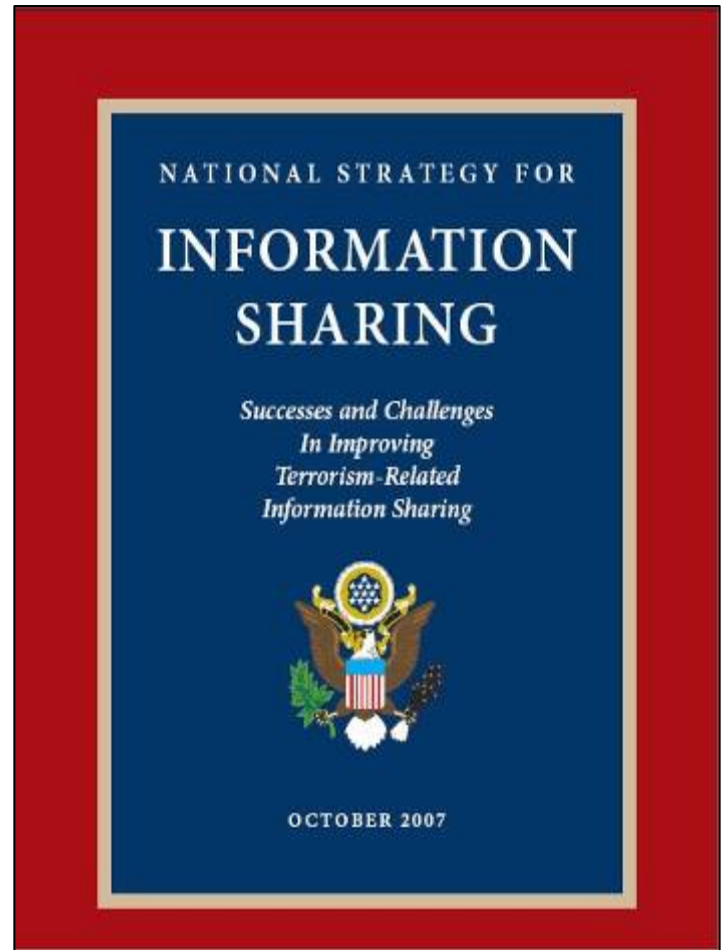

# Fusion Center Creation

- Department of Homeland Security Federal Guidelines
  - Created to analyze and disseminate information between Federal, State and Local agencies
- Fusion Centers
  - Created to serve as information hubs where intelligence information can be shared between frontline officers and the Intelligence community

# Philosophy

- Continuous exchange of information
  - Recognize all crimes and hazards approach
  - Identify criminals
  - Develop patterns in local criminal activity that pose a domestic threat to the security of the city, state and country
  - Maintain partnerships



# Liaison Agencies

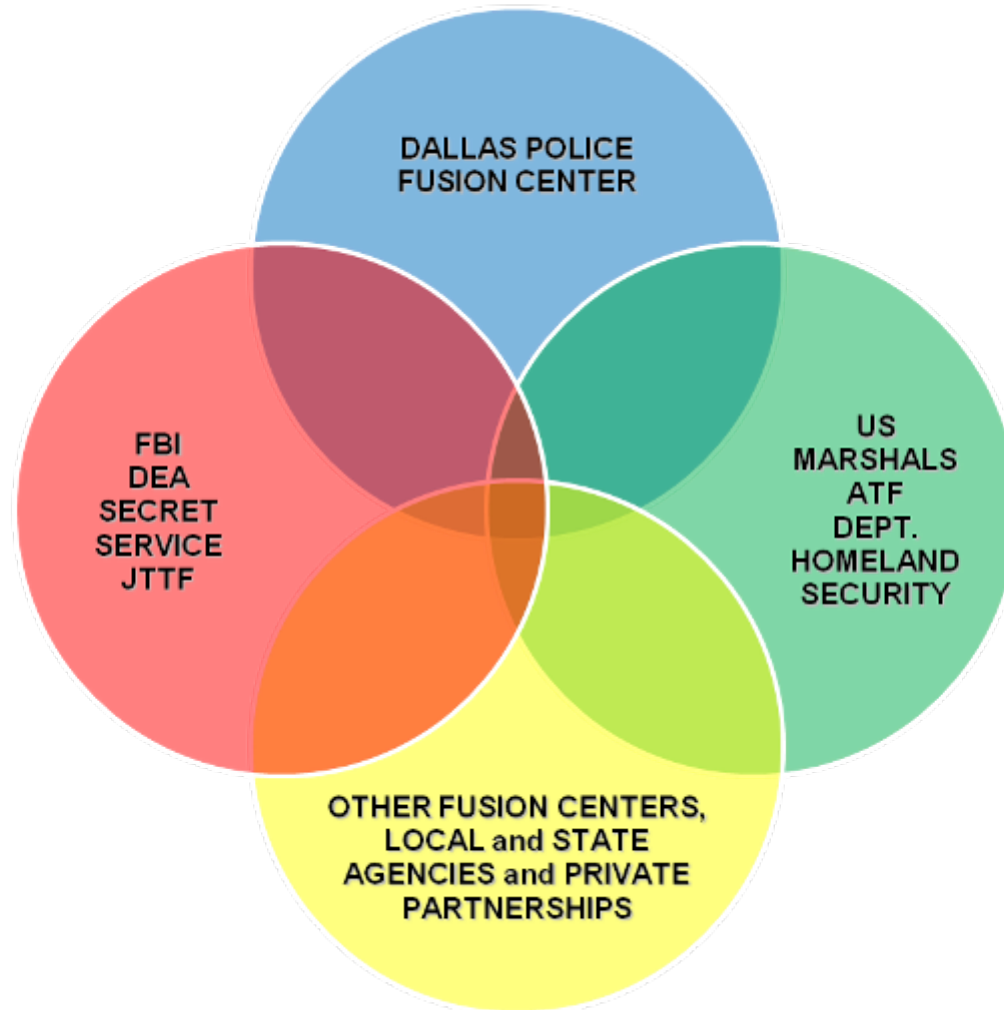

# DPD Fusion Key Partnerships

- Federal
  - FBI; JTTF; DEA; EPIC; DHS; ATF; HIDTA; USSS
- County
  - Sheriff, Probation
- Texas Department of Criminal Justice
  - Bureau of Prisons, Parole
- Dallas Independent School System
- Dallas Area Rapid Transit

# DPD Fusion Key Partnerships

- Texas Fusion System
  - North Texas, Austin, Houston
- Medical
  - County Medical Director, Southwestern Medical
- Water
  - EPA Early warning contamination pilot program
- National SAR Initiative
- Integrated with Fire



# DPD Fusion Key Partnerships

- Private Partnerships
  - Hotel/Motel Association
  - LEAPS (Law Enforcement Assisting Private Security)
  - Organized Retail Crime
  - Infragard
- Critical Infrastructure Protection/BZPP
  - Digital Sandbox
  - Orator Plus
  - NTCOG Fusion Subcommittee
  - CI/KR Data Calls

# DPD Fusion Center

- Timeline
  - Operations began January 17, 2007
  - Dallas became the 40<sup>th</sup> Fusion center in the Nation, 4<sup>th</sup> in Texas
  - Expanded to evening shift May 2007
  - 24/7 operations by mid 2008
  - Full time DPS Analyst assigned Nov 2008



# Dallas Police Department Fusion Center

11:27 2:27 2:27 4:27 5:27 8:27  
 NAME LOS ANGELES PHOENIX DALLAS WASHINGTON LONDON

Unit	Class	Div	Off	Call Address	Appt	Location Name	Unit Description	Unit Current Location	Status	Alt Unit
546	C224	At Scene	58	NORTHWEST ST HWY/PH				NORTHWEST HWY/PH	OK	C536
537	C224	Enr	40983	2234 Utah Ave			2234 Utah Ave	11 WOODS AVE/ SANC	OK	C724,C75
537	C251	Enr	40981	7234 Utah Ave			2234 Utah Ave	5 LANCASTER PRINCE DA	OK	C724,C75
519	C245	At Scene	58	18300 LOMBARDY LN			18300 LOMBARDY LN	60 LOMBARDY LN	OK	0546
514	C241	At Scene	58	COMMERCET ST PAUL			COMMERCET ST PAUL	COMMERCET PAUL	OK	L243
499	C234	At Scene	58	130'S BEAT			130'S BEAT	130'S BEAT	OK	F236
496	C251	At Scene	58	BEAT 251			BEAT 251	BEAT 251	OK	C253
492	C256	At Scene	58	HAWNSTAUG			HAWNSTAUG	HAWNSTAUG	OK	C647
		Enr	40	3770 Spring Valley Rd			3770 Spring Valley Rd	HORLEBET BNCLEARIN	OK	C634
		At Scene	13	13740 Moorhous Dr	2410	REGAL 15 CMB	13740 Moorhous Dr	13740 Moorhous Dr	OK	C754
		At Scene	58	BEAT 754			BEAT 754	BEAT 754	OK	C122
		Enr	40	Main St / N Ervey St	138		Main St / N Ervey St	1458 PRESTON	OK	C124
		At Scene	79	Commerce St / S St Paul St			Commerce St / S St Paul St	Commerce St / S St Paul St	OK	C134,L249
		At Scene	79	Commerce St / S St Paul St			Commerce St / S St Paul St	Commerce St / S St Paul St	OK	C134,L249
		At Scene	79	Commerce St / S St Paul St			Commerce St / S St Paul St	Commerce St / S St Paul St	OK	C552,L148
456	L143	At Scene	79	Commerce St / S St Paul St			Commerce St / S St Paul St	Commerce St / S St Paul St	OK	C552,L148
462	C532	Enr	97	1332 Fwy E3 / March Ln			1332 Fwy E3 / March Ln	1332 Fwy E3 / March Ln	OK	C552,L148
462	L143	Enr	97	1332 Fwy E3 / March Ln			1332 Fwy E3 / March Ln	1332 Fwy E3 / March Ln	OK	C552,L148
444	C251	At Scene	198	1346 Utah Blvd			1346 Utah Blvd	1346 Utah Blvd	OK	C724

  

Unit	Div	Address	Div	Appt	Location Name	Unit	Map	Assigned	Vehicle Info	Class
547	04	2 13340 Austelia Rd	254	126	adit alterations	TRIFARY TRUCKING	17-G	00:00:14	09-101-4002	
528	58	7 18300 LOMBARDY LN	529			W NORTHWEST HWY/		00:02:27	09-101-3987	
524	58	7 18300 LOMBARDY LN	529			W NORTHWEST HWY/		00:02:43	09-101-3983	
521	46	2 Frazier St / Commerce	134	CENR		S LLEWELLYN AVE/	46-G	00:02:46	09-101-3980	
522	04	2 807 Wynnewood Dr	446			S HIGH HILL PL/	54-G	00:02:46	09-101-3981	
518	139	3 1983 High Hill Blvd	710		goodhaven apt	S HIGH HILL PL/	54-G	00:02:55	09-101-3578	C368
588	3101	1 8885 St Thomas Cir	271		SHADOW GLEN APPT	ST FRANCIS AVE/INT F	48-8	00:03:49	09-101-3958	
581	826	2 12488 Abrams Rd	253	725	treebend condos	PINYON TREE RD/	17-S	00:04:15	09-101-3963	
498	127	2 E R L Thornton Fwy E3	151				45-T	00:04:26	09-101-3959	
497	58	7 BEAT 251					00:04:32	09-101-3958		
489	16	3 1738 Grace Rd	224			RUNNINGBROOK LANE	38-U	00:05:33	09-101-3958	
473	40	3 10800 Walnut St	256		OFFICE THE PARKS AT WILMAUND	13A TDW/WHISPER	17-V	00:06:15	09-101-2234	
466	053	2 13800 Redbrook Dr	026			MAVLEE BL/	72-1	00:06:38	09-101-3930	0E30





# URBAN AREA SECURITY INITIATIVE FUNDING

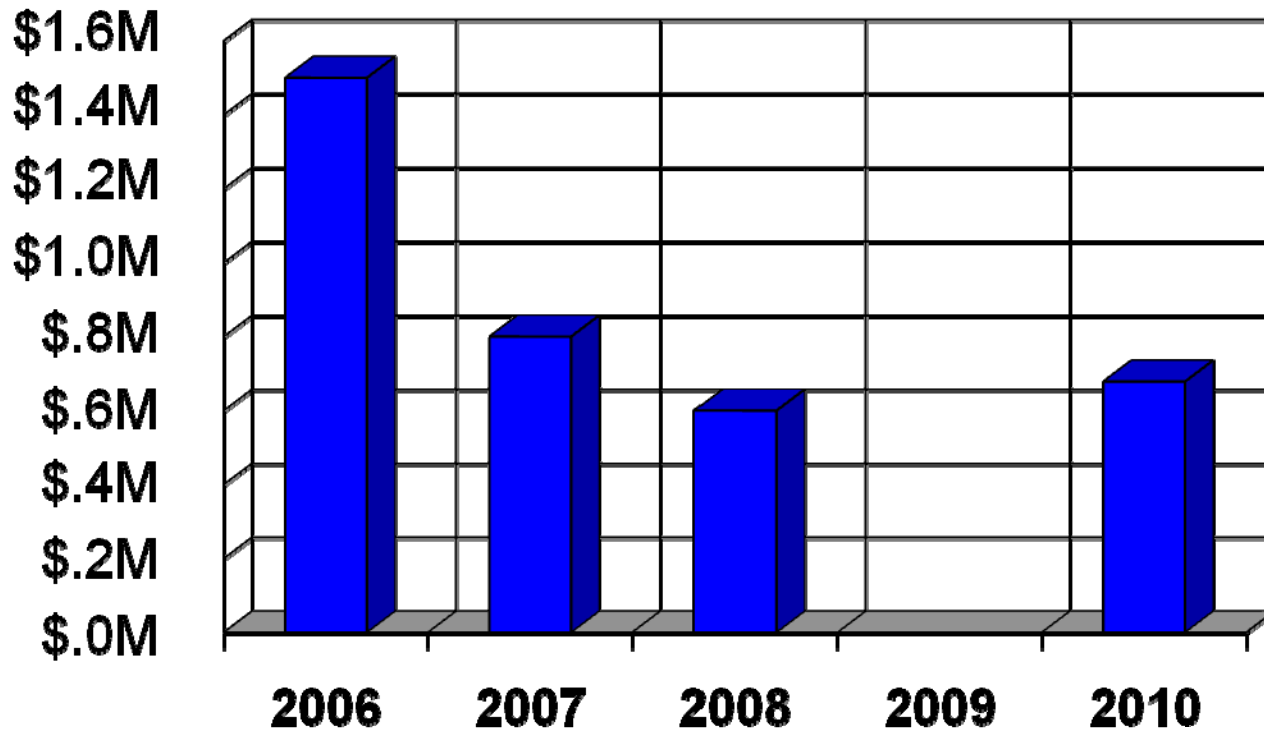

**CURRENT FUNDING WILL SUPPORT OPERATIONS THROUGH 2012**

Total Grant funding received has been \$3,578,425.00. Annual maintenance for sustainability is approximately \$300,000. per year.

# Privacy Policy

- Fusion adheres to the criminal intelligence guidelines under the National Criminal Intelligence Sharing Plan (NCISP)
- All information accessed will be based on a criminal predicate or threat to the public
- Information will not be collected concerning political, religious, social views of individuals or groups unless the activity directly relates to criminal conduct

# Fusion Center Supports



- Homeland Security by:
  - Collecting of critical infrastructure data and dissemination to key resources
  - Developing site profiles for CI/KR locations to assess vulnerabilities and assist in incident response
  - Implementing methodologies and protocols for the timely, reliable and accurate bi-directional communication of relevant information between public sector and vetted private sector partners
  - Providing point of entry into National Suspicious Activity Reporting systems
  - Monitoring criminal activity for a nexus to terrorism
  - Accessing 113 city cameras for criminal intelligence



# Fusion Center Supports



- Department by:
  - Gathering information and serving as intelligence hub of the Police Department
  - Collecting, evaluating, collating, analyzing, reporting and disseminating intelligence relating to potential all-hazard, all-crime threats
  - Conducting real-time tactical crime analysis to providing immediate information to officers in the field
  - Providing real-time data mining to support investigative or operations Units
  - Monitoring “State of the City” by monitoring events and resources
  - Administering iWatchDallas program

# Utilizes Multiple Databases

- Federal/National/State
- County/Regional/Internal
- Open source/Internet
- At a centralized location, officers
  - Can research requested information
  - Search various databases with the fragments of info officers provide to identify suspect
  - Cross reference located data with other databases to produce a refined product
  - Receive timely actionable intelligence shared in the field and throughout network

# Fusion Center Capabilities

- Cell Phone Tracking
  - Exigent Circumstances/imminent danger in conformance with Federal Regulations
  - Coordinate with provider and receive the latitude/longitude coordinates for cell phone
- Video Retrieval
  - Surveillance video (Analysis and Photo stills)
- Agency Bulletins
  - Analyzed bulletins regarding Wanted Violent Offenders, Officer Safety and Intelligence
  - Provided to North Texas region
- Real Time Dissemination
  - Monitor CAD system / Police traffic for request
  - Timely actionable intelligence

# Fusion Center Capabilities

- i2 Analyst Notebook
  - Provides support for Detectives and Federal Agencies
  - Shows link analysis of people, places, and things (cell phones, money, etc)
  - Conduct social network analysis
  - Analyze time-line series
  - Simplifies complex cases to graphical representation
  - Is useful in gaining convictions in court



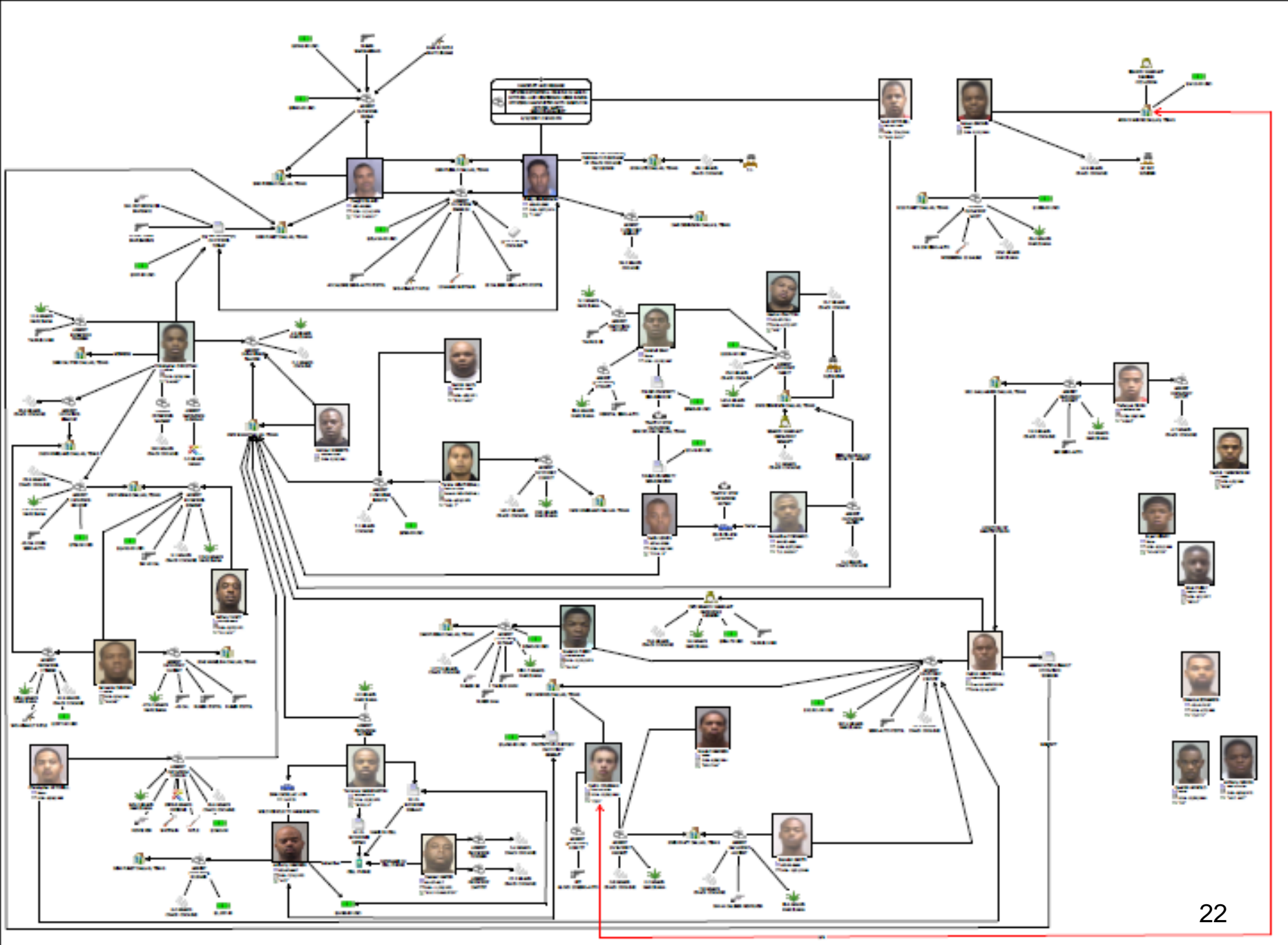

# Fusion Center Networking Capabilities

- Enables us to receive information from over 100 Fusion Centers nationwide
  - Processed 28,963 internal and external requests for information during 2010 and 16,398 YTD
  - Officers generated 119,096 intranet hits on Fusion products in 2010 and 70,277 YTD
- Exchanges intelligence information with domestic and international agencies

# Major Criminal Investigations

- Participated in several major criminal investigations
  - Murder of a DPS Trooper in Tyler, Texas
    - Gathered information from TX Department of Corrections, vehicle buyer, and cell phone research
  - East Dallas murder
    - Suspect arrested based on cell phone tracking

# Major Criminal Investigations

- Chase Bank Robbery and Shooting
  - Coordinated live feed from Chase corporate security to tactical officers
- Serial Vehicle Arsonist in North Oak Cliff
  - Data analysis, research and video surveillance
- Coordinated North Texas ATM theft investigation
  - Intensive analysis, multi agency coordination and intelligence dissemination

# iWatchDallas.net

- Initiated October 2010
- Allows tip submission through
  - Smart phone applications
  - Text to DPD Crimes (274637)
  - Online at [iwatchdallas.net](http://iwatchdallas.net)
  - 214-671-4TIP
- Information is researched by Fusion Detectives and sent to appropriate units for follow-up
- Development funded by Safer Dallas/Better Dallas



# iWatchDallas General Flow Chart

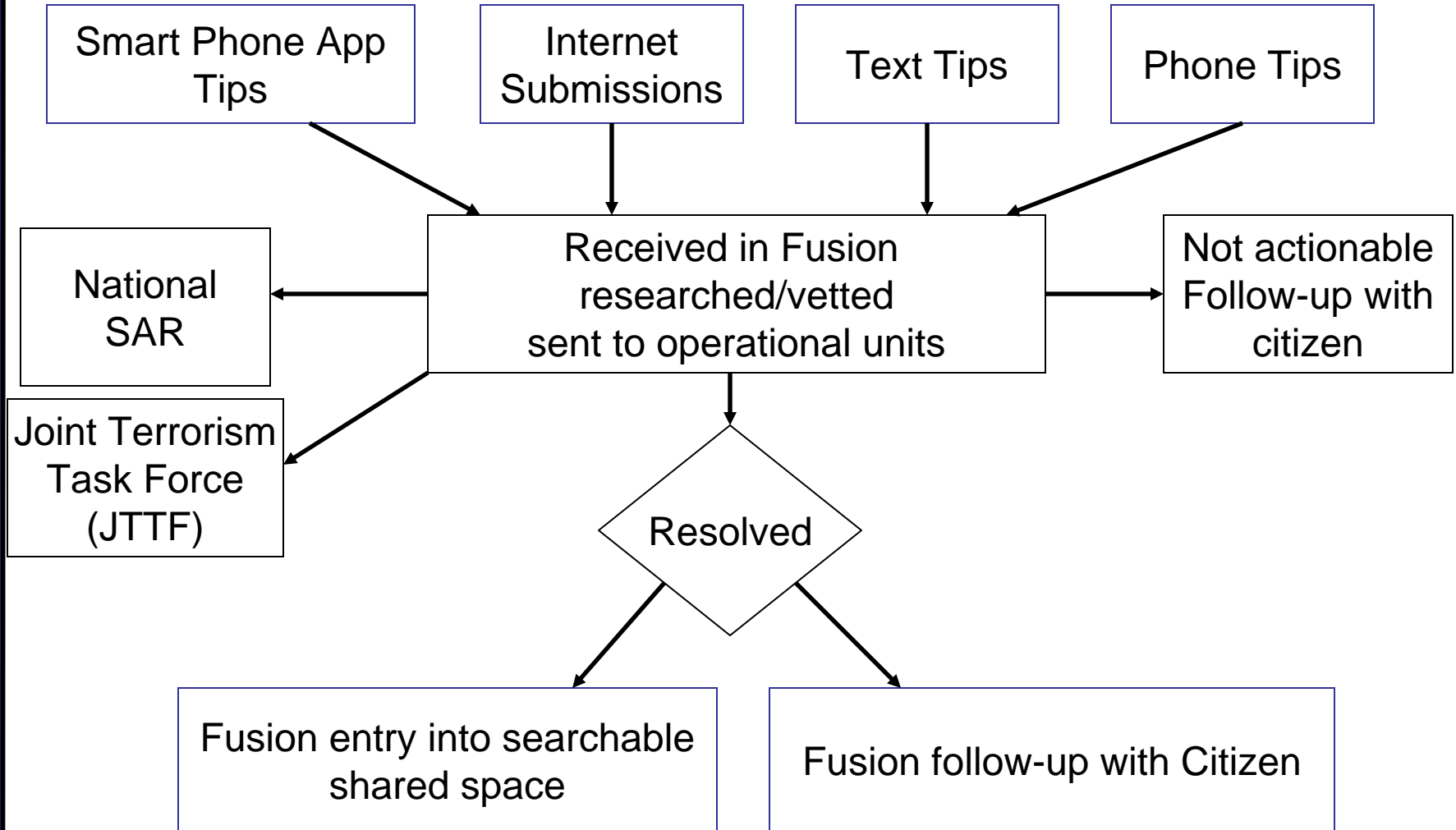

# iWatchDallas Tips to Date

## 934 Actionable Tips

- 468 Public Nuisance
- 258 Drug related
- 128 Property Crime
- 41 Vice/Sex Crimes
- 24 Fugitive
- 15 Homicide

## 68 Arrests

- 49 Misdemeanor
  - Drug Possession
  - Evading Arrest
  - Prostitution
  - Hit and Run
- 19 Felony
  - Felony Drug Possession
  - Felony Warrant Arrests
  - Criminal Mischief

# iWatchDallas Improvements

- Safer Dallas Better Dallas is working to enhance [iwatchdallas.net](http://iwatchdallas.net)'s mobile presence
- Council members can help by promoting [iwatchdallas.net](http://iwatchdallas.net) through their community contacts

# Summary

The Fusion Center provides valuable Homeland Security and crime reduction intelligence by strengthening analysis capabilities and capitalizing on partnerships.



Homeland  
Security

**QUESTIONS?**